



SMARTPAT ORP 1590 Technical Datasheet

Digital ORP sensor for the water and wastewater industry

- 2-wire loop powered sensor with integrated transmitter technology
- Offline calibration function
- Pure platinum electrode and ceramic diaphragm

HART 
COMMUNICATION PROTOCOL

1	Product features	3
1.1	SMARTPAT ORP sensor.....	3
1.2	Design and options	4
1.3	ORP measurement	5
2	Technical data	6
2.1	Technical data.....	6
2.2	Dimensions	8
3	Installation	9
3.1	General notes on installation	9
3.2	Intended use	9
3.3	Pre-installation requirements	10
3.4	Installing the sensor.....	11
3.4.1	General installation instructions.....	11
4	Electrical connections	12
4.1	Safety instructions.....	12
4.2	Connecting the cable to the sensor	12
4.3	Connecting the sensor cable.....	12
4.3.1	Connection diagram.....	13
5	Order information	16
5.1	Order code	16
5.2	Consumables and accessories.....	17
6	Notes	18

1.1 SMARTPAT ORP sensor

SMARTPAT analytical sensors from KROHNE are the first and only sensor line in the market with integrated transmitter technology. The complete circuitry is miniaturised and fits into the sensor head. This technical achievement cuts the price in half compared to all measurement systems without integrated transmitter technology.

KROHNE is the only company who offers a real open standard without additional external transmitter and with a direct connection via standardised fieldbus from the sensor to the process control system. The SMARTPAT sensor stores all data and sends these as bidirectional digital signals with 4...20 mA / HART[®] 7 protocol to the control and asset management systems, handhelds, PC and other peripherals.

The SMARTPAT ORP 1590 meets all requirements of the water and wastewater industries.

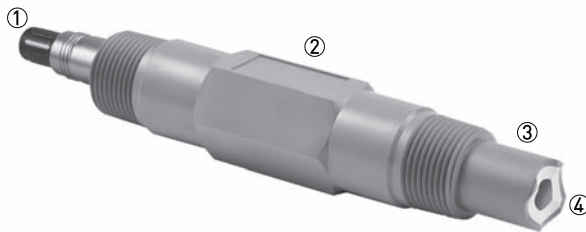

- ① Cable connector VarioPin 2.0 (VP2)
- ② CPVC body
- ③ Diaphragm
- ④ Platinum electrode

Highlights

- Pure platinum electrode and ceramic diaphragm for long service and reliable ORP measurement
- Double junction for extended lifetime and a wide application range
- Robust design with CPVC body material
- Low maintenance - high potential of cost saving with offline calibration under controlled conditions
- With integrated Pt1000 and standard VP2 connector

Industries

- Water
- Municipal wastewater
- Industrial wastewater

Applications

- Potable water
- Monitoring of surface and wastewater
- Process water monitoring

1.2 Design and options



The sensor type is equipped with a very pure platinum electrode, ceramic diaphragm and Pt1000.

The sensor can be easily adapted to various application requirements and can be installed directly into a pipe or tank with the 3/4-14 NPT (male) process connection.

The sensor can be integrated into the process control system via PACTware™ (FDT/DTM) with the open standard in fieldbus systems - HART®.

The SMARTPAT ORP 1590 sensor is compatible with all 2-wire loop powered displays.

Made to Fit

Mounting assemblies SENSOFIT series

As a complete provider for water analysis, we naturally offer a complete range of assemblies, like retractable, immersion and flow-through assemblies, in a wide range of materials. Special versions for special operating conditions are available on request.

For the SMARTPAT ORP 1590 sensor type the following individual assemblies are available:

- SENSOFIT IMM 2000 series - Immersion assemblies

For further information please consider the technical datasheets.

1.3 ORP measurement

The oxidation reduction potential, ORP in short, is the measurement for the concentration of oxidising and reducing agents in water. Its value is influenced both by pH and temperature. ORP is a sum parameter that gives no information on the concentration of a single substance in a mixture.

ORP measurements are used to monitor chemical reactions involving electron transfer. In drinking water treatment it can be found in ozone treatment and the removal of iron, manganese and nitrate as well as in disinfection steps. In swimming pools the German DIN 19643 requires ORP measurements as a hygiene parameter and decrees maximum and minimum values for fresh water, pool water, and salt water. In wastewater treatment ORP is measured in the denitrification process and in detoxication of industrial wastewater.

The ORP sensor consists of a measuring electrode of platinum or gold and a reference of e.g. Ag/AgCl. The potential of the measuring electrode changes with the concentration of reducing and oxidising agents and is measured against the reference. The measured values can be recalculated to fit literature values based on NHE (normal hydrogen electrode) as reference.

2.1 Technical data

- *The following data is provided for general applications. If you require data that is more relevant to your specific application, please contact us or your local sales office.*
- *Additional information (certificates, special tools, software,...) and complete product documentation can be downloaded free of charge from the website (Downloadcenter).*

Measuring system

Measuring principle	Potentiometric
Measuring range	-1500...+1500 mV

Design

Shaft diameter	20 mm / 0.79"
Insertion length	23 mm / 0.91"
Temperature sensor	Pt1000
Connector	VarioPin 2.0 (VP2)

Operating conditions

Process temperature	0...+80°C / +32...+176°F
Ambient temperature	-10...+85°C / +14...+185°F
Storage temperature	4...+30°C / +40...+86°F
Process pressure	Max. 5.9 bar at +60°C / 85 psi at +140°F
Conductivity	> 150 µS/cm

Installation conditions

Ingress protection	IP68
Weight	Approx. 193 g / 0.43 lb
Process connection	3/4-14 NPT (male)

Materials

Sensor shaft	CPVC
Measuring electrode	Platinum
Inner buffer	pH 7.0
Reference	KCl gel double junction
Diaphragm	Ceramic
Sensor head	Nickel plated brass body with VP2 connector

Communication

ORP range	-1500...+1500 mV
Output signal	4...20 mA (passive)
Output resolution	20 μ A
Field communication	HART [®] 7 - FSK 1200 physical layer definition on top of the current loop
Time constant	1...60 seconds

Electrical connections

Power supply	15...30 VDC loop powered
Measuring range	4...20 mA + HART [®] protocol
Load	Minimum 0 Ω ; maximum $R_L = [(U_{ext.} - 15 \text{ VDC}) / 22 \text{ mA}]$
Error signal	Acc. to NAMUR NE 43 Upper value: $\geq 21.0 \text{ mA}$
HART [®]	HART [®] protocol via current output
Device revision	1
Physical layer	FSK
Device category	Sensor, galvanically isolated
System requirements	250 Ω loop resistance for HART [®] communication
Multidrop operation	4 mA In a multidrop communication system, up to 32 devices can be connected. For installation in a multidrop communication system please consider the voltage drop for the 250 Ω loop resistance for HART [®] communication. The supply voltage has to be adjusted.

Approvals

CE	This device fulfils the statutory requirements of the EC directives. The manufacturer certifies successful testing of the product by applying the CE mark.
Shock resistance:	IEC 60068-2-31, Environmental testing – Part 2: Test Ec
Electromagnetic compatibility:	Acc. to EN 61326, NAMUR NE 21 EMC Directive 2004/108/EC (valid until 2016/04/19) or EMC Directive 2014/30/EU (valid from 2016/04/20)

For further information contact your local sales office.

2.2 Dimensions

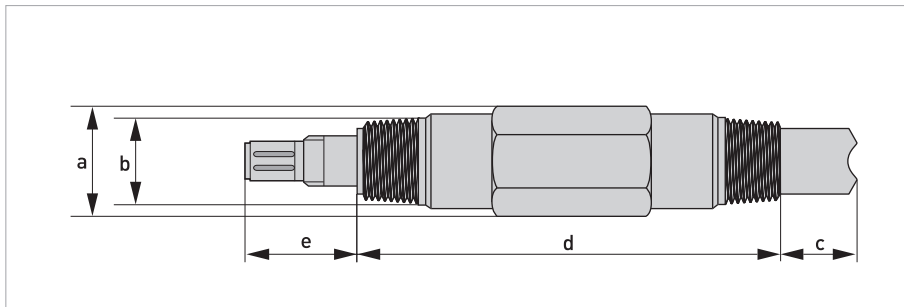

Figure 2-1: SMARTPAT ORP 1590 with VP2

	Dimensions [mm]	Dimensions [inch]
a	Ø 33	Ø 1.3
b	3/4 - 14 NPT (male)	
c	24	0.94
d	128	5.04
e	34	1.34

3.1 General notes on installation

For devices used in hazardous areas, additional safety notes apply; please refer to the Ex documentation.

All work on the electrical connections may only be carried out with the power disconnected.

Observe the national regulations for electrical installations!

During installation of the device make sure that you use ESD (electrostatic discharge) protection equipment.

Observe without fail the local occupational health and safety regulations. Any work done on the electrical components of the measuring device may only be carried out by properly trained specialists.

Inspect the packaging carefully for damages or signs of rough handling. Report damage to the carrier and to the local office of the manufacturer.

Do a check of the packing list to make sure that you have all the elements given in the order.

Look at the device nameplate to ensure that the device is delivered according to your order.

3.2 Intended use

Responsibility for the use of the measuring devices with regard to suitability, intended use and corrosion resistance of the used materials against the measured fluid lies solely with the operator.

The manufacturer is not liable for any damage resulting from improper use or use for other than the intended purpose.

The intended use of SMARTPAT ORP 1590 sensor is the measurement of ORP value in water applications.

3.3 Pre-installation requirements

- *Do not drop the device! Handle the device with care!*
- *Never touch or scratch the platinum electrode of the sensor.*
- *Store the sensor in its original packaging in a dry, dust-free location. Keep it away from dirt. If necessary, clean it as described in the manual of the sensor.*
- *Do not make any mechanical modifications to the sensor (electrodes shortened, drilled, bent or scratched). This can result in the loss of proper functionality, as well as the rights under the device warranty.*
- *The sensor must be suitable for the temperature, pressure and medium conditions which are specified (including chemical resistance).*

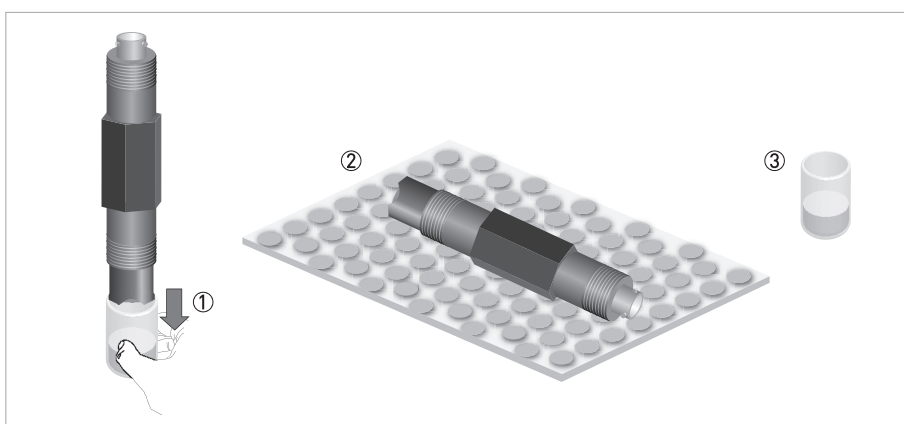

Figure 3-1: Unpacking the sensor

Unpacking the sensor

- Gently pull the protection cap from the sensor ①.
- Lay the sensor on a soft mat/tissue ②.
- Keep the protection cap in the original packaging ③.

3.4 Installing the sensor

3.4.1 General installation instructions

The sensor tip must always have full contact with the measuring medium.

The mounting position of the sensor should not deviate more than 75° from vertical position (sensor tip pointing downwards). Doing otherwise might cause internal air bubbles to float into the sensor tip. This would interrupt the electrical contact between the inner buffer solution and the platinum surface.

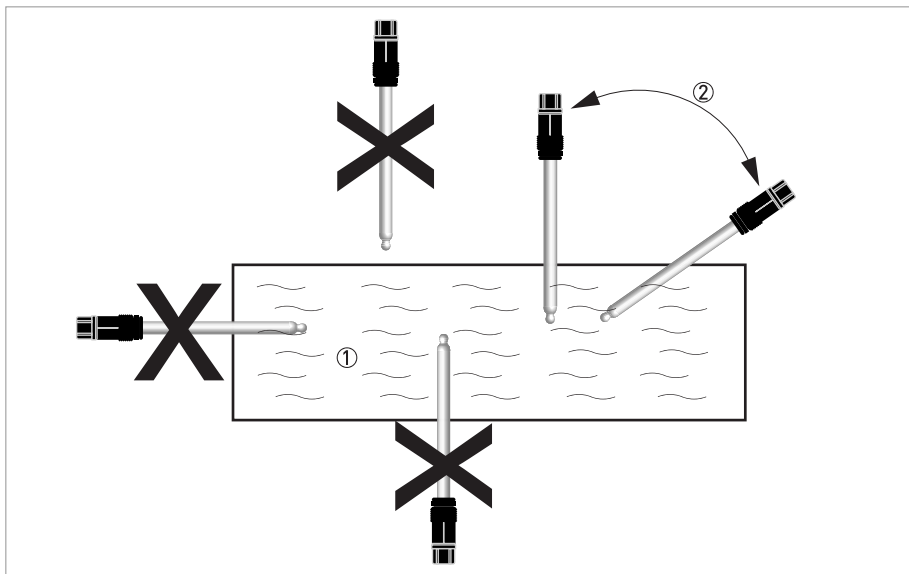

Figure 3-2: Installation requirements

- ① Measuring medium
- ② Maximum deviation of 75° from vertical position

4.1 Safety instructions

All work on the electrical connections may only be carried out with the power disconnected.

Observe the national regulations for electrical installations!

Observe without fail the local occupational health and safety regulations. Any work done on the electrical components of the measuring device may only be carried out by properly trained specialists.

Look at the device nameplate to ensure that the device is delivered according to your order.

4.2 Connecting the cable to the sensor

During installation of the device make sure that you use ESD (electrostatic discharge) protection equipment.

Moisture on the sensor connector must be avoided! Moisture may cause a short-circuit and a malfunction of the sensor!

If moisture has entered the connector dry it with air (e.g. hot air gun).

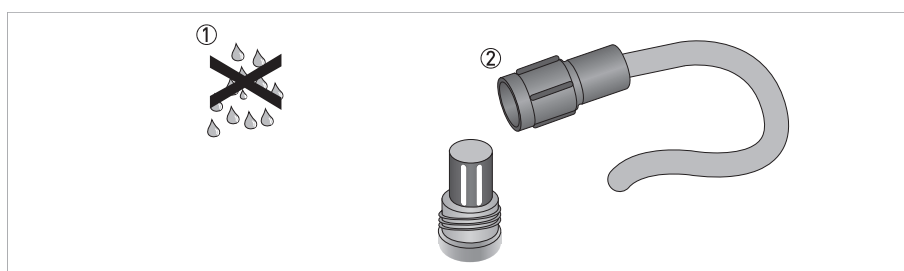

Figure 4-1: Connecting the cable to the sensor

Connecting the cable to the sensor

- Ensure that both cable and sensor connector are absolutely dry ①.
- Screw the cable connector ② on the sensor connector and tighten it by hand.

4.3 Connecting the sensor cable

All work on the electrical connections may only be carried out with the power disconnected.

The cable glands installed by the manufacturer are designed for a cable diameter of 8 mm... 13 mm / 0,31"...0,51". If you are using cables with a larger diameter, you must replace the manufacturer's cable glands with suitable ones. The operator is responsible for the correct sealing of cable glands.

Cable VP2-S

Transparent-black (inner coax shield)	Ub+
White	Ub-
Shield	S

4.3.1 Connection diagram

Connection to SJB 200 W-Ex

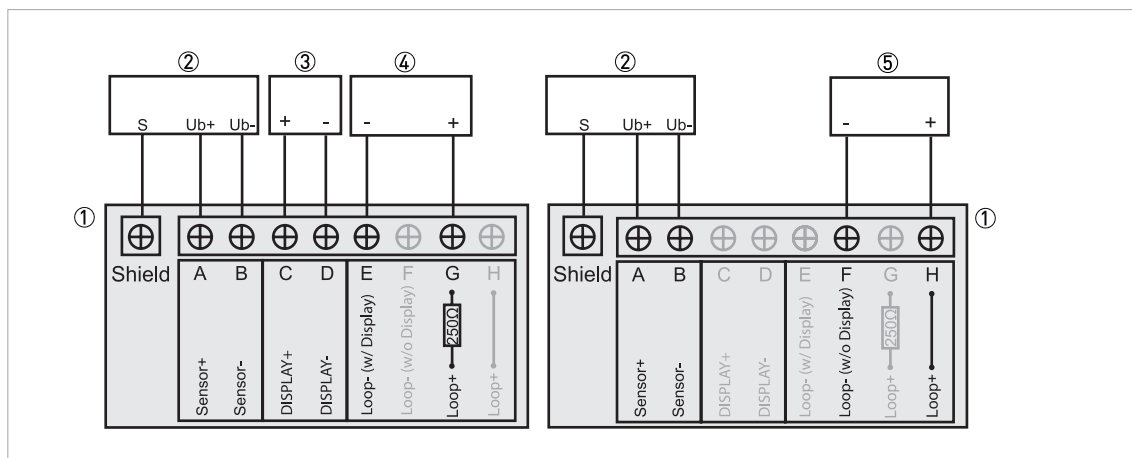

Figure 4-2: Example of a connection with a SJB 200 W-Ex junction box

- ① SJB 200 W-Ex junction box with or without internal resistor used
- ② Sensor with VP2-S cable
- ③ Display or other 4...20 mA loop powered device (e.g. data logger)
- ④ Control system without internal 250 Ω resistor connected to internal resistor of SJB 200 W-Ex
- ⑤ Control system with internal 250 Ω resistor connected to SJB 200 W-Ex without using internal resistor

SJB 200 W-Ex with internal resistor		SJB 200 W-Ex without internal resistor	
S	Shield	S	Shield
A	Sensor +	A	Sensor +
B	Sensor -	B	Sensor -
C	Display +	F	Loop - w/o Display
D	Display -	H	Loop +
E	Loop - w/ Display		
G	Loop + [250Ω]		

HART® interface within SJB 200 W

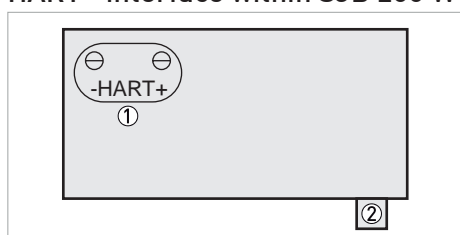

Figure 4-3: Example of a HART® handheld connection

- ① Connection via crocodile clips
- ② **Only for Ex:** M12 connector for the HART® handheld connecting cable

Connection of SMARTMAC 200 W with loop powered device via optional SJB 200 W-Ex junction box to a SMARTPAT Sensor.

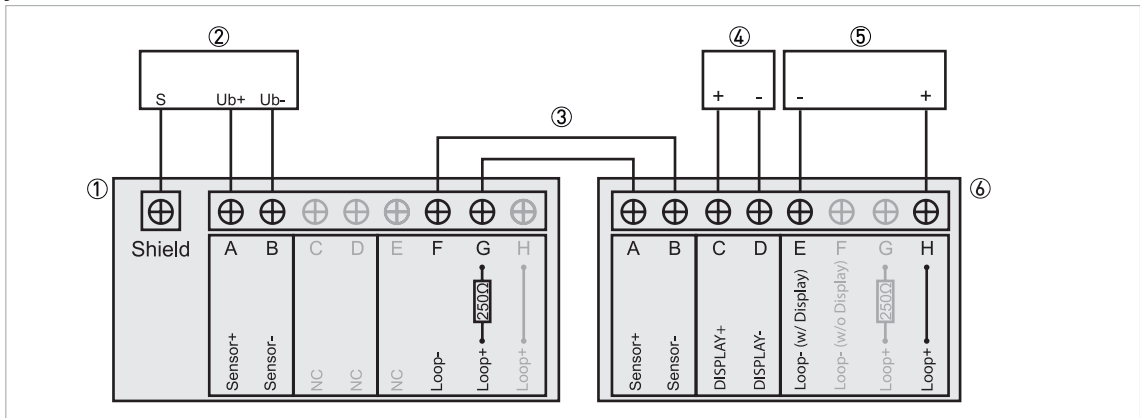

Figure 4-4: Example of connecting the SMARTMAC 200 W to a control system without internal 250 Ω resistor and one additional loop powered device.

- ① SMARTMAC 200 W
- ② Sensor with VP2-S cable
- ③ Cable connection between SJB 200 W-Ex and SMARTMAC 200 W
- ④ Display or other 4...20 mA loop powered device (e.g. data logger)
- ⑤ Control system without internal 250 Ω resistor
- ⑥ SJB 200 W-Ex junction box

SMARTMAC 200 W with internal resistor		SJB 200 W-Ex without internal resistor	
S	Shield	A	Sensor +
A	Sensor +	B	Sensor -
B	Sensor -	C	Display +
F	Loop -	D	Display-
G	Loop + [250Ω]	E	Loop - w/ Display
		F	Loop- (w/o Display)
		G	Loop+ [250Ω]
		H	Loop +

The SJB 200 W offers the opportunity to access the sensor via HART® hand held. For further information refer to the manual of the SJB 200 W.

Connection with sensor and control system

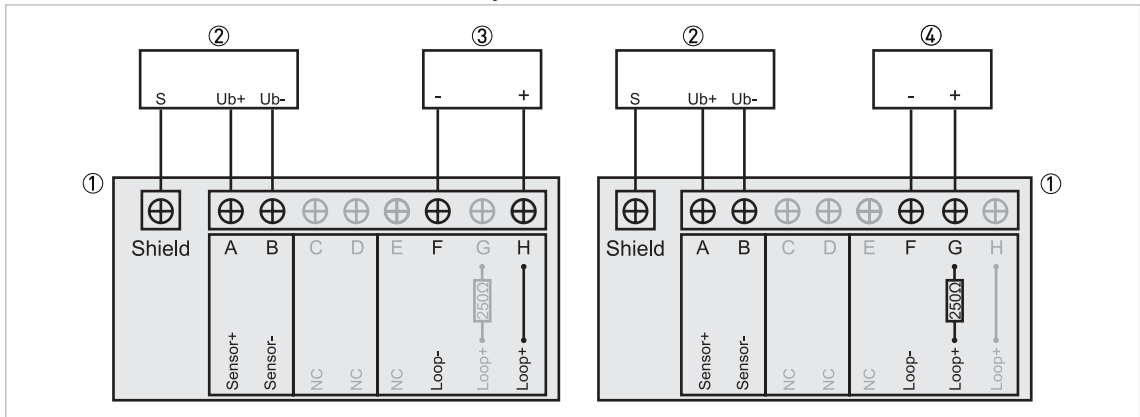

Figure 4-5: SMARTMAC 200 W connection to a control system with internal 250 Ω resistor (left side). SMARTMAC 200 W connection to a control system without internal 250 Ω resistor (right side).

- ① SMARTMAC 200 W
- ② Sensor with VP2-S cable
- ③ Control system with internal 250 Ω resistor
- ④ Control system without internal 250 Ω resistor

SMARTMAC 200 W without internal resistor		SMARTMAC 200 W with internal resistor	
S	Shield	S	Shield
A	Sensor +	A	Sensor +
B	Sensor -	B	Sensor -
F	Loop -	F	Loop -
H	Loop +	G	Loop + [250Ω]

5.1 Order code

The characters of the order code highlighted in light grey describe the standard.

VGS U	4	Sensor type																		
		A	SMARTPAT ORP 1590																	
			Diaphragm																	
		5	Ceramic																	
			Reference																	
		B	KCl gel double junction																	
			Process conditions																	
		1	0...+80°C, 5.9 bar / +32...+176°F, 85 psi																	
			Insertion length																	
		A	23 mm / 0.9"																	
			Body material																	
		3	CPVC																	
			Communication																	
		A	4...20 mA / HART® not suitable for SMARTMAC																	
		B	4...20 mA / HART® (SMARTMAC)																	
			Connector type																	
		4	VP2; Body: nickel-plated brass																	
			Approval																	
		0	none																	
			Documentation																	
		0	none																	
		2	English																	
		3	German																	
		4	French																	
		5	Spanish																	
		6	Italian																	
		7	Turkish																	
VGS U	4																			

5.2 Consumables and accessories

Accessories	Order code
-------------	------------

Display

SD 200 W - Indicator for SMARTPAT sensors, wall mount	VGSD 4 1A2A20x
SD 200 R - Indicator for SMARTPAT sensors, rack mount	VGSD 4 2A3A00x
F400 (SD 200 W-EX) - Indicator for SMARTPAT sensors, wall mount, Ex	VGSD 4 1A2A2Cx
D400 (SD 200 R-EX) - Indicator for SMARTPAT sensors, rack mount, Ex	VGSD 4 2A3A0Cx

USB interface cable

SMARTBRIDGE - USB interface cable for SMARTPAT sensors	XGA S 080010
FSK USBex - USB interface cable for SMARTPAT sensors, Ex (additional Ex separator required)	XGA S 080015

Junction box

SJB 200 W-Ex - Junction box for connecting sensor with process control system, Ex	XGA S 080013
---	--------------

Cable for SMARTPAT sensors

Consumables	Order code
Cable VP2-S-3 (3 m / 9.84 ft)	XGA W 080130
Cable VP2-S-5 (5 m / 16.4 ft)	XGA W 080140
Cable VP2-S-10 (10 m / 32.8 ft)	XGA W 080150
Cable VP2-S-15 (15 m / 49.2 ft)	XGA W 080160
Cable VP2-S-20 (20 m / 65.6 ft)	XGA W 080170
Cable VP2-S-30 (30 m / 98.4 ft)	XGA W 080180

ORP buffer solution to verify the sensor

Consumables	Order code
250 ml 465 mV ORP test solution	XGA S 010061
250 ml 220 mV ORP test solution	XGA S 010065







KROHNE – Process instrumentation and measurement solutions

- Flow
- Level
- Temperature
- Pressure
- Process Analysis
- Services

Head Office KROHNE Messtechnik GmbH
Ludwig-Krohne-Str. 5
47058 Duisburg (Germany)
Tel.: +49 203 301 0
Fax: +49 203 301 10389
info@krohne.com

The current list of all KROHNE contacts and addresses can be found at:
www.krohne.com

KROHNE