

# Dräger Flame 5000

## Colour CCTV Flame Detector

### Technical Manual

en

Technical Manual

2 - 34



#### WARNING

You must read, understand, and follow these instructions for use before you use the flame detector in order to ensure the proper operation and function of the flame detector.

# Contents

For Your Safety.....	3
Intended Use .....	6
Operation .....	20
Maintenance .....	21
Fault Finding .....	23
Technical Specifications .....	24
Approvals.....	26
Accessories.....	27
Supplier's Declaration of Conformity .....	28
Approval Certificates.....	29

## For Your Safety

### Strictly follow the Instructions for Use

Any use of the device requires full understanding and strict observation of these instructions. The device is only to be used for the purposes specified herein. This manual should be carefully read by any individuals who have or will have responsibility for using or maintaining this product.

### Maintenance

The Dräger Flame Detector 5000 must be inspected and serviced at regular intervals and a record kept. Repair and general over-haul of the device may only be carried out by trained service personnel. We recommend that a service contract be obtained with Dräger Safety UK Ltd and that all repairs also be carried out by them.

Under no circumstances should the detector housing be opened in a hazardous area. Detectors contain no user-serviceable parts and should never be opened, other than for access to the terminal compartment. Under no circumstances should any components be substituted. Failure to comply with this requirement may invalidate the hazardous area certification or disturb the critical parameters of the Dräger Flame Detector 5000 resulting in damage to the device or failure to detect fires. Observe the chapter 'Maintenance'.

### Use in areas subject to explosion hazards

The Dräger Flame Detector 5000 is certified for and intended for use in potentially hazardous areas. Equipment and components which are used in explosion-hazard areas and which have been inspected and approved in accordance with international or European explosion-protection regulations may be used only under the specified conditions. The equipment or components may not be modified in any manner. Do not drill holes in any housing, as this will invalidate the explosion protection.

Check that the materials used in the construction of this detector are compatible with the environment in which they will operate, and that they will not be affected by any anticipated contaminants. The detector should not be used in an oxygen enriched atmosphere.

The purpose of the Dräger Flame Detector 5000 is to detect a flame or fire. It may be installed in areas that contain potentially explosive atmospheres, thus it is vital for your safety and that of others that its functions are understood and that every aspect of installation, commissioning and maintenance are carried out correctly.

This manual is intended to inform you of all aspects of the Dräger Flame Detector 5000. However, if you are in any doubt about any part of these instructions, any function of the equipment, or any operating procedure, please contact Dräger Safety or your local distributor.

## **Attention**

Information on power consumption and operating voltage of the detector can be found in the specifications section of this manual. This should be read and taken into consideration when specifying cable core sizes to be used. In addition, local regulations should be considered before wiring the system and installation should be completed by appropriately trained personnel.

During system tests or maintenance, it is important that any control equipment is inhibited to avoid unwanted actuation or alarms.

**Dräger Safety UK Ltd.**

## Safety Symbols used in this Manual

While reading this Manual, you will come across a number of warnings concerning some of the risks and dangers you may face while using the device. These warnings contain “signal” words that will alert you to the degree of hazard you may encounter. These words, and the hazard they describe, are as follows:

 <b>DANGER</b>
Indicates an imminently hazardous situation which, if not avoided, will result in death or serious injury.

 <b>WARNING</b>
Indicates a potentially hazardous situation which, if not avoided, could result in death or serious injury.

 <b>CAUTION</b>
Indicates a potentially hazardous situation which, if not avoided, could result in physical injury.

 <b>NOTICE</b>
Indicates a potentially hazardous situation which, if not avoided, could result in damage to the product.

## Intended Use

### Dräger Flame Detector 5000

For use in an area which may contain potentially explosive atmosphere. Used to monitor and trigger the necessary control actions upon the detection of fire or flame in a given environment

## Understanding the System

### Principle of Operation

The Dräger Flame Detector 5000 can operate 'stand alone' or can be integrated with an approved control system. Detectors are typically located throughout the installation in order to achieve specific detection coverage and ensure that site performance requirements are met. All detectors are capable of providing live colour video images and fire alarm/fault signalling to the control equipment. Each detector incorporates within a single unit an imaging device, digital signal processing hardware, and firmware algorithms to process live video images and recognise flame features. The detectors are capable of operating independently: external control equipment is not required for normal functions. However, if an external controller is installed then certain additional features become available, such as remote configuration and firmware management. A remote operator can interrogate the detector and, during an alarm situation, visually verify the hazard. Each detector can be individually configured to operate separately as a Flame detector only, or Video Surveillance camera, or as a combined unit.

### Detector Overview

The detector unit is comprised of two primary components, the detector enclosure, and the detector assembly. The detector assembly should not be disassembled or tampered with in any way. The detector is shipped pre-assembled and comes complete with all parts required for installation, including the bracket but excluding the client mounting support, glands and cabling.

### Optical Test

The camera implements an optical check for faulty or contaminated optics. The check measures the contrast in images captured from the video sensor. If the contrast falls below a certain level, the detector will signal an optical fault. Optical testing in the Visual Flame Detector can also be verified manually using the Dräger FS-5000. Another manual method is simply to view the video from the detector, if the video-out is connected.

### Detector Sensitivity

The Dräger Flame Detector 5000's response to a fire depends on the fuel source and how it is released, fire size and distance, orientation to the detector and local ambient conditions. The typical parameters can be made available by contacting Dräger Safety UK Ltd.

### Explosion-Protection Approval

The explosion-protection approvals are valid for use of the device in gas/vapour-air mixture of combustible gases and vapours under atmospheric conditions. The explosion-protection approvals are not valid for use in oxygen enriched atmospheres. In the case of unauthorised opening of the enclosure, the explosion-protection approval is void.

<b>!</b>	<b>WARNING</b>
Do not open the enclosure in the presence of an explosive atmosphere.	
<b>!</b>	<b>WARNING</b>
All permits and proper site procedure and practises must be followed and the equipment must be isolated from the power supply before opening the enclosure in the field.	

### Field of View

The sensor can detect fires of 0.1m<sup>2</sup> or greater, at 44m within a 90° horizontal field of view. The detector will only respond to visible flames within the field of view. Hence the detector will not to certain common sources of false alarms such as reflected flare radiation. This also reduces the likelihood of cross-propagation of alarms caused by fires or combustion products of fires burning out with the field of view.

The detectors should be aligned to view the intended hazard taking into account any obstruction and congestion. Software analysis of the actual detector coverage may be required to ensure adequate coverage of the hazards. This analysis can also be used to optimise the number of detectors and the loop configuration.

Visual Flame Detector does not have a traditional cone of vision like other IR flame detector's. The detector's field of view is a rectangular pyramidal shape and represents a radial projection of the detector's rectangular sensing element. The illustrations below show the Field of View and range for a fire of 0.1m<sup>2</sup>.

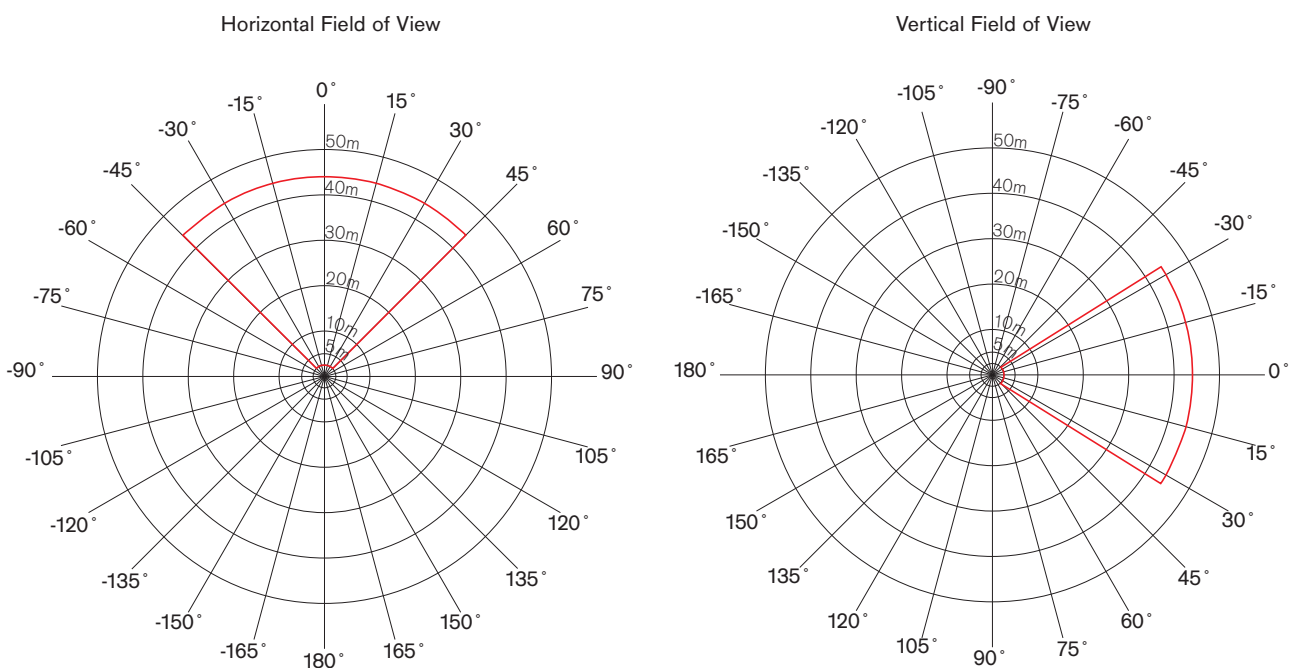

## Installation of the Dräger Flame Detector 5000

In considering the application of the Dräger Flame Detector 5000 it is important to know of any conditions that may prevent the detector from responding. The detector provides reliable response to visible flames within its field of view, and insensitivity to common false alarm sources.

Solid obstructions or a direct view of intense light sources may interfere with the detector sensitivity. Scaffolding or tarpaulins in the detector's field of view may reduce coverage. Contamination of the detector window may result in a reduction in sensitivity.

The detector provides a live colour video image for surveillance of the protected area. As with conventional video cameras the detector should not face directly towards the sun or a brightly lit scene. In such conditions the detector's automatic exposure control would darken the image in order to avoid overexposure; the resulting picture may be too dark for surveillance purposes. To obtain the best possible picture the detector should be facing away from the sun. In the case of an offshore vessel or platform, the detector should ideally be placed facing inwards towards the plant and with minimal view of the horizon.

The detector has a horizontal field of view of 90° and a vertical field of view of 65°. The location and orientation of the detector in relation to the protected area determines the actual footprint. Achieving the desired coverage depends on congestion within the protected space, the location of the detector(s) and the distance of the detector from the hazard. It may be necessary to install more than one detector within an area in order to achieve adequate coverage.

The detector sensitivity, expressed as fire size at a distance, is determined visually by the apparent size of the fire. This is a function of the fuel source, how it is released and distance from the detector to the fire. The detector response time is relatively independent of fuel type and/or distance.

In common with other forms of flame detection, the detector's sensitivity is reduced and potentially blinded by dense obscuring agents such as smoke, fog and other airborne particulates. The detector is insensitive to arc welding, however should not be conducted within 1m of the detector.

### Mechanical Install.

#### Detector Enclosure

The Draeger Flame Detector 5000's electronics are housed in an enclosure certified for use in a hazardous areas. The enclosure comprises of:

- Front enclosure cover (including the faceplate window)
- Rear enclosure cover.
- Enclosure body (with certification label).
- Mounting bracket.

The mounting bracket allows the detector's vertical orientation to be adjusted from 0-45°, and allows a horizontal rotation of  $\pm 45^\circ$ .



## Detector Enclosure with Bracket



### Sighting requirements

Observe the following:

- Ensure the mounting position is free from vibration or movement
- Prevent accidental knocking or forcing out of alignment
- Where snow or ice build-up is likely, the heater should be enabled
- To ensure the best possible video image the detector should be facing away from the sun
- Isolate as far as possible from local electrical interference sources
- Ensure sufficient detection to achieve adequate coverage for all likely hazards
- Minimise exposure to contamination of the detector face plate
- Ensure ease of maintenance access to detector (i.e. direct, ladder or scaffold access)

All these issues are of crucial importance to a successful installation, and they should be given great attention during the detailed design, construction, and commissioning phases of the work.



### WARNING

Do not drill any holes in the housing as this will invalidate the explosion protection.



### WARNING

Do not open the enclosure in the presence of an explosive atmosphere.

### **Exposure to Flare Radiation**

Flame detectors are frequently used where hydrocarbon fire hazards are expected; these are quite often processing plants where a flare stack is in use nearby. The detector should not have a direct view of the flare.

### **Flexibility of mounting location**

The detector requires a clear unobstructed view of the potential hazard. In order to avoid local obstructions, such as pipe-work and cable trays, a 2m helix should be provided in the detector cable to allow local repositioning of the detector.

### **Mounting Arrangements**

Firm, vibration free mountings are essential for the operation of optical systems and the detector should, wherever possible, be fixed to rigid mountings.

### **Thermal Disruption**

Thermal convection plumes and exhaust gas plumes generally exhibit a visual 'mirage' effect. In most cases this does not affect detector operation or sensitivity. The detector does not respond to black body radiation near the exhaust.

### **Optical Contamination**

There are many sources of contamination such as oil, water (deluge water, rain and sea-spray), snow, ice, and internal misting. The design of the detector incorporates an internal heater in order to resist condensation and ice build-up. Excessive contamination of the detector faceplate may result in an increased maintenance requirement and potentially reduce the detector's sensitivity.

Where detectors are mounted at low level, care should be taken to avoid contamination (such as water and oil) from equipment above the detector. Care should be taken in sighting the detector to minimise the likelihood of such contamination.

Fog, smoke and other similar airborne contaminants affect the detector's sensitivity by reducing the detector's range.

### **Enclosed Areas**

In enclosed areas, if dense smoke is expected to accumulate at the onset of the fire, the detectors should be mounted 1-2m below the ceiling level.

### **The mounting bracket**

The detector mounting bracket is designed to allow the detector to be mounted from a horizontal plane. The bracket supplied with the detector and the dimensions of the fixing holes are illustrated on the following page.

### Detector mounting bracket

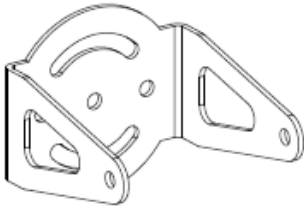

### Detector mounting bracket dimensions

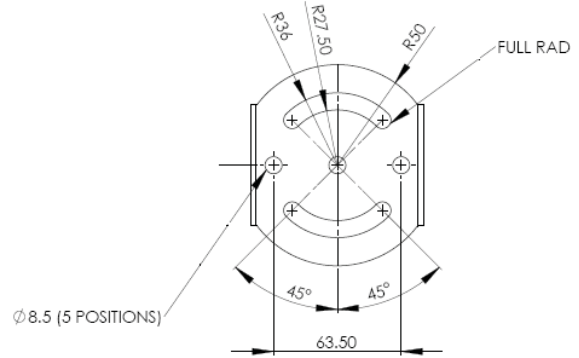

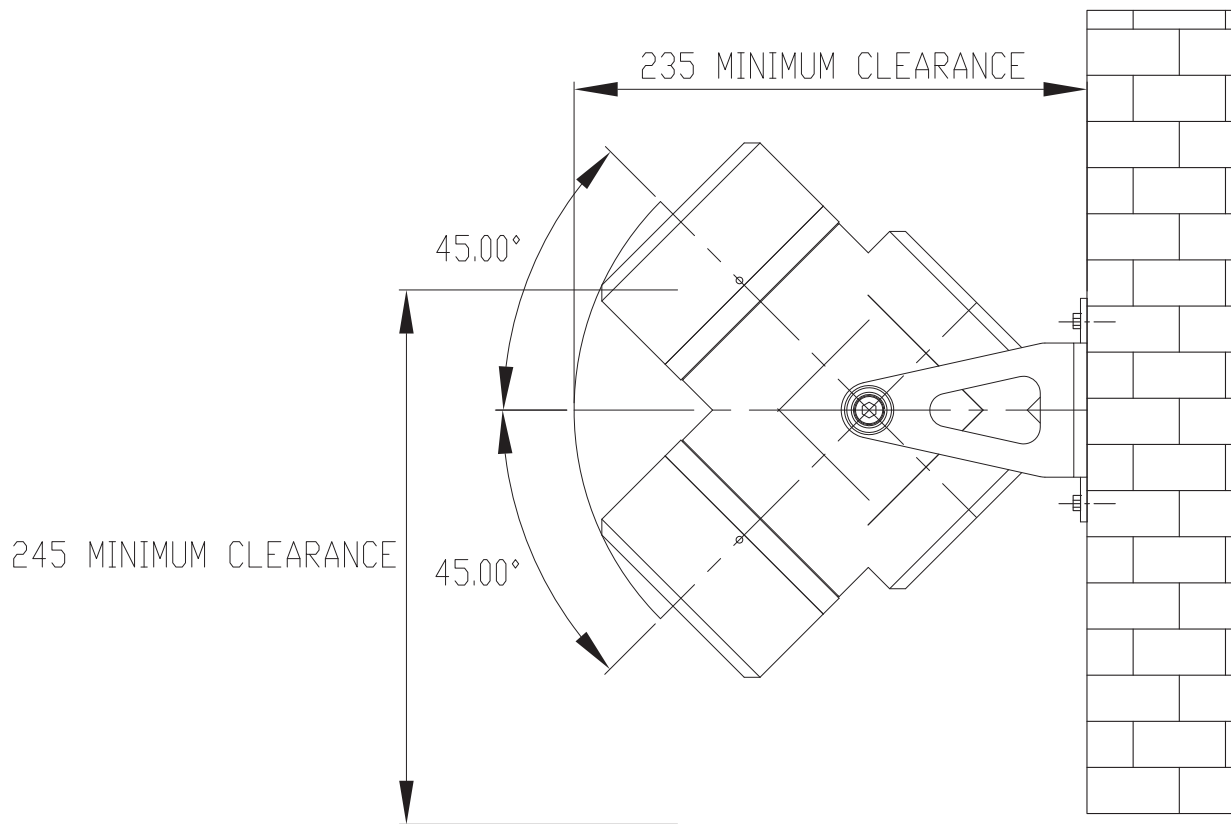

Dimensions shown in Millimeters



## Electrical Install

### Detector Electronics Subassembly

The field wiring is accessed by removing the rear enclosure cover and all terminations are accessible without the need to access the electronics module mounted in the front portion of the enclosure.

 <b>WARNING</b>
For European (ATEX) installations, IEC/EN60079-14 'Electrical Installations in Hazardous Areas' and ICE/EN60079-17 'Inspection and Maintenance in Hazardous Areas' should be strictly observed.
 <b>WARNING</b>
For installations all Local and International regulations should be strictly observed.

### Earthing & Screening Requirements

It is important to ensure that the system is correctly connected to earth. Incorrect or poor earthing can adversely affect system operation and may result in intermittent RS485 communications and poor video image quality.

 <b>WARNING</b>
The equipment must be properly earthed to protect against electrical shock and to minimise electrical interference.

The system 0V should be connected to a clean earth at only one point; generally this should be at the panel power supply (or 0V bus bar). Where PC equipment is connected to the RS485 and Video signals, care should be taken to ensure that the PC's and Panel's power supply are at the same ground potential. Even small differences in earth potentials can cause an earth fault current to flow resulting in video corruption. Where this is not possible either the PC's local supply should be isolated and the PC's connected to the 'system clean earth', or alternatively, the Video and RS485 signals should be isolated. The Dräger Safety UK Ltd twisted pair to BNC video converter (VTP4) and RS232 to RS485 converter (RS2485IF) can be used so long as the maximum potential difference between each earth does not exceed  $\pm 5V$ , as identified below.

In distributed systems with multiple DC-DC power supply units all 0V supplies must be connected together to a common clean earth. Where this is not possible each system can either be connected to a local clean earth so long as the maximum potential difference between each earth does not exceed +4 to -1Vdc, alternatively the Video and RS485 signals can be galvanically isolated from the central system. Where earth fault monitoring is used care should be taken to ensure that the system 0V to earth potential is not exceeded.

The detector enclosure is to be connected to a local earth and the detector cable screens (shields) should be cut back to the crotch and not terminated within the detector. If the detector enclosure cannot be connected to a local earth

then care should be taken to ensure the cable armour braid provides a suitable earth or that the enclosure earth stud (external) is separately connected to a suitable earth point using a single core 4mm<sup>2</sup> earth cable.

All detector cable screens should be connected to the local clean earth at the control panel. The screens (and twisted pairs) should be maintained to within 1" (25.4mm) of the terminations at the detector, within all junction boxes and at the control panel. Where unscreened cables are used for panel wiring, then all cables must be suitably twisted into pairs and video cables should be segregated from other signal sources.

### **Power Supply**

The detector requires an absolute minimum supply voltage of 18V, as measured at the detector terminals. The system power supply voltage and power distribution should be arranged such that on the longest cable run the detector(s) has a supply voltage of greater than 18V. All detectors must share a common 0V supply. In distributed systems with multiple DC-DC power supply units all 0V supplies must be connected together. Where this is not possible the RS485 and Video signals may need to be galvanically isolated, such as with a fibre optic transceiver.

To prevent RS485 communications or video corruption the maximum voltage drop on the 0V return must not exceed +4V or -1V. Voltages greater than these will exceed the common mode input range of the RS485 and Video drivers. Power supply cable selection is described in section: Detector Power Supply Cabling

### **Detector Wiring Terminals**

The wiring terminals and configuration links are mounted in the rear section of the enclosure and are accessible by removal of the rear cover from the enclosure. The electronics and the field terminals are separated so that there is no reason to remove the electronics in order to access the field terminals. This is to prevent damage to the electronics when the unit is being connected to the field cable.

The device is supplied in one of two options:

1. As a unit that provides relay contacts for the alarm and fault circuits across which alarm and end of line resistors are fitted. When the unit is disconnected from the fire panel, the output from terminals A and B switch to the RS485 protocol; this allows a Dräger Engineer access to the detectors configuration from the local equipment room.
2. As a unit that provides 4-20mA output. When the unit is disconnected from the fire panel, the output from terminals A and B switch to the RS485 protocol; again this allows a Dräger Engineer access to the detectors configuration from the local equipment room.

This may then be used to access the software revision within the detector via the 'get settings' menu as described in the 'RS485 Communications' section.

The alarm relay and the 4-20mA output is factory selectable for latching and non-latching operation. If the latching mode is selected then if an alarm is generated the detector will remain in alarm until the power supply to the unit is interrupted. If the non-latching operation is selected then the detector will remain in alarm for a minimum of 15 seconds, the fire panel to which the detector is connected must be capable of latching the alarm and there is no need to interrupt the power supply to the detector to reset the alarm. Local authority having jurisdiction approval is required for connection to FM Approved fire alarm control units.

### Detector Wiring Terminals (Rear Detector with cover removed)

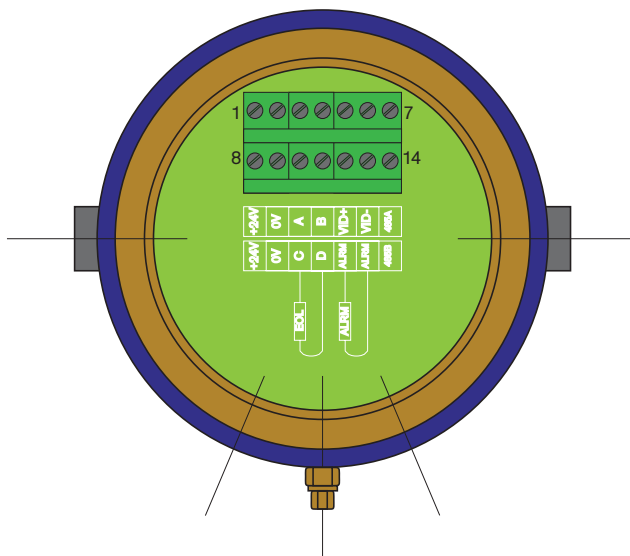

### Relay Mode Connections

The following table provides a function summary of each terminal if the detector is ordered in relay mode.

Terminal	Terminal No.	Description
+24v	1	+24V Supply A
0v	2	0V Supply A
A	3	Sense from fire panel
B	4	Return signal to fire panel
VID+	5	Video +Ve
VID-	6	Video -Ve
485A	7	RS485 termination +Ve
+24v	8	+24V Supply B
0v	9	0V Supply B
C	10	EOL resistor
D	11	EOL resistor
ALRM	12	Alarm Resistor
ALRM	13	Alarm Resistor
485B	14	RS485 termination -Ve

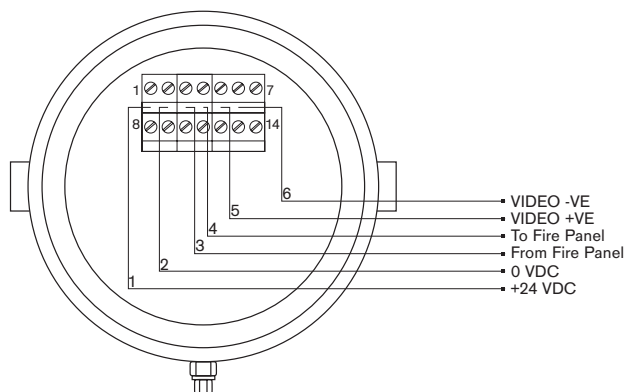

If the detector is connected in the above manner and if a fire alarm is signalled, with the alarm resistor connected between terminals 12 & 13, then the alarm resistor will appear across terminals 3 & 4. The EOL resistor connected between terminals 10 & 11 normally appears across terminals 3 & 4 and in the event of a fault the resistor appears open circuit. If terminals 3 & 4 are disconnected from the fire panel, these wires then provide a RS485 connection to the detector. This connection may then be used to up load or down load information to the detector.

## 4–20mA Connections

The following table provides a function summary of each terminal if the detector is ordered in 4-20mA mode.

Terminal	Terminal No.	Description
+24v	1	+24V Supply A
0v	2	0V Supply A
A	3	Tie to +24 Volts at panel
B	4	4-20 mA source
VID+	5	Video +Ve
VID-	6	Video -Ve
485A	7	RS485 termination +Ve
+24v	8	+24V Supply B optional
0v	9	0V Supply B optional
C	10	Not used
D	11	Do not connect
ALRM	12	Do not connect
ALRM	13	Not used
485B	14	RS485 termination -Ve

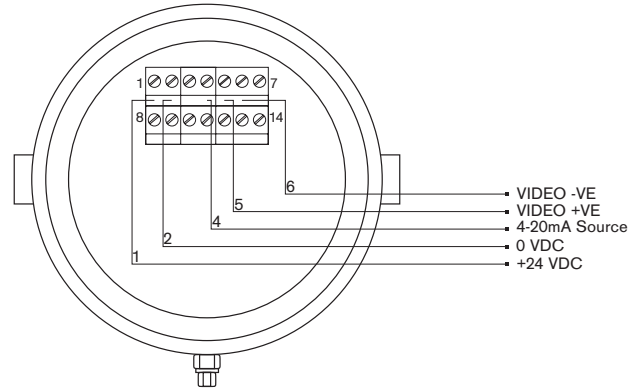

If the detector is connected in the above manner if a fire alarm is signalled then the 4-20mA outputs generate 18mA if a fault develops the 4-20mA signal indicates 0 or 2 mA dependant on the fault see table for default current levels. If terminals 3 & 4 are disconnected from their connections these wires then provide a RS485 connection to the detector. This connection may then be used to up load or down load information to the detector.

### Default 4-20mA settings

Event	Output
Catastrophic Failure	0mA
Optical Fault	2mA
Healthy condition	4mA
Alarm	18mA
Over range	21mA

There is a tolerance on the mA outputs of  $\pm 5\%$ , other values maybe selected at the point of order.

## RS485 Communications

The optional RS485 twisted pair cable is connected to the detector RS485A +ve signal terminal and the RS485B -ve signal terminal. The RS485 connection can be used to read the software revision within the detector. In order to access this information connect the RS485 input of a RS485 to RS232 to terminals 7 & 14. Connect the RS232 input of a RS485 to RS232 to a PC install DFG software on the PC. The DFG Software can be used to interrogate the Flame 5000 Detector, for any further assistance contact Dräger Safety UK Ltd.

The software revision will be shown in the get settings box as indicated adjacent.

### Video (twisted pair)

The video twisted pair cable is connected to the detector +Video signal on terminal 5 and the -Video signal on terminal 6.

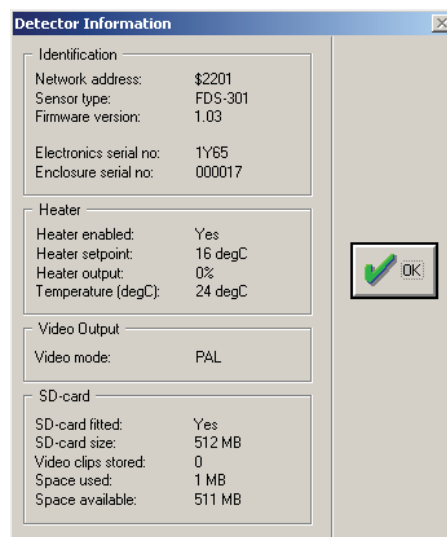

## Point to Point Connections

In a point to point connection a single detector is connected to the power, RS485 (or mA or Relays) and Video cables. This arrangement has the best reliability and availability since any single failure in the field equipment or cabling affects only the one detector.

## Cable Selection

The installation, local regulations, and standards determine the overall cable specification. This section specifies suitable cable characteristics to ensure correct operation of the flame detector. There are several different cabling methods available, each with advantages and disadvantages:

- Three twisted pair cable, one each for DC power, RS485 and video signals
- Two twisted pair cable for DC power and mA or Alarm relays, interchangeable with RS485
- Three twisted pair cable for DC power and mA, or Alarm relays, interchangeable with RS485 and one pair for video.
- Three wire, DC power and mA (Current source output).

NOTE: Table below shows absolute maximums for cable lengths; try not to approach these values.

### Typical cable lengths (24V Supply)

Installation based on 24V nominal supply	Number of Flame Detectors	Maximum Power (W)	Maximum Cable Length (m) with 1.5mm <sup>2</sup> Conductors (12 ohms/km)	Maximum Cable Length (m) with 2.5mm <sup>2</sup> Conductors (7.6 ohms/km)
Detector and Heater	1	18	333	506
Detector (no Heater)	1	6	1,000	1,578

NOTE: Increasing the supply voltage to 26V would increase the maximum cable lengths by +30%.

The overall performance and the transmission distance depends on the selected twisted pair cable. Individually screened twisted pairs offer better electrical immunity.



It is not necessary for the DC power cable to be a twisted pair or individually screened, a 2-core stranded cable with an overall screen is sufficient. The minimum conductor size is determined by the cable length, the number of Flame Detectors on each loop, and the maximum allowed voltage drop at the last detector.

To prevent RS485 and Video common mode problems this is limited to a maximum of four volts (4V) on the negative supply (0V).

**Equation 1 : DC Supply Conductor Resistance Calculation**

$$V_{pd}(\leq 4V) = \frac{V_{s\ min} - V_{d\ min}}{2}$$

$$R_{km} = \left( \frac{V_{pd} \div \left( \frac{Pd \times N}{V_{s\ min}} \right)}{L_{km}} \right)$$

Vpd	= Potential across each conductor (limited to ≤4V)
Vsmin	= Minimum Supply Voltage
Vdmin	= Minimum Detector Voltage (18V)
Pd	= 18 watts per Flame Detector (inc. Heater) or 6 watts excluding Heater
N	= Number of Detectors
Lkm	= Cable Length in Kilometres
Rkm	= Maximum Conductor Resistance per Kilometre

Use the value of R<sub>km</sub> calculated above to select a suitable gauge of conductor, alternatively, to calculate the maximum cable length from a known conductor resistance swap R<sub>km</sub> and L<sub>km</sub> in the above equation. The supply voltage and cable cross-sectional area (which equates to its resistance) limits the maximum cable length, increasing the supply voltage (up-to a maximum of 32V) can dramatically increase cable length.

Prudence dictates that a cable is selected with a lower resistance than calculated above, with sufficient allowance for the effects of crimps, terminals and ageing which can increase overall resistance. Where a single cable cross sectional area cannot be found to satisfy both the needs of the power and signal conductors consideration should be given to using multiple paralleled conductors of a smaller cross section for the power.

**Video (Twisted Pair)**

The video cabling should be a twisted pair stranded cable with an overall screen. Where multi-core cables are used then individual screened twisted pairs are recommended. The cable should have the following characteristics:

**Video (Twisted Pair) Cable Characteristics**

Cable Characteristic	Characteristic Impedance	Capacitance	Conductor Resistance	Attenuation @ 1MHz	Inductance
Nominal	150Ω	50nf/Km	- -	- -	- -
Absolute Limit	90Ω to 150Ω	100nf/Km	150R	6db	0.7mH/Km

The maximum cable length is dependent on the cable manufacturer's attenuation specification, which is approximately proportional to conductor size.

The characteristic impedance of a transmission line is a function of the physical dimensions of the conductor and the permittivity of the dielectric (the insulation), at high frequencies this is approximately equivalent to:

## Equation 2: Characteristic Impedance Calculation

$$Z_0(\Omega) = \sqrt{L \div C}$$

L	= Cable Impedance (mH)
C	= Cable Capacitance (µF)
Z <sub>0</sub>	= Characteristic Impedance (Ohms)

The RS485 communications cabling should be a twisted pair stranded cable with an overall screen. Where multi-core cables are used then individual screened twisted pairs are recommended. The cable should have the following characteristics:

### RS485 Communications Cable Characteristics

Cable Characteristic	Characteristic Impedance	Capacitance	Conductor Resistance	Attenuation @ 1MHz	Inductance
Nominal	120Ω	50nf/Km	--	--	--
Absolute Limit	90Ω to 120Ω	100nf/Km	120Ω	12dB	0.7mH/Km

The maximum cable length is dependent on the cable manufacturer's attenuation specification, which is approximately proportional to conductor size. The characteristic impedance of a transmission line is the same as for the video above.

## Installation Check-Points

Experience has shown that poor installation and commissioning practice may result in an unreliable fire detection system that is prone to malfunction, unwanted alarms, and at the same time fails to meet the site performance targets. Before installing the detector it is important to take into account where it is to be located and how it is to be mounted.

### Mechanical Installation

- When locating the Dräger Flame Detector 5000 consideration should be given to maintenance access to the detector.
  - The detector mounting should be secure and vibration free.
  - It is advisable to check the detection locations, prior to fabrication of the mounting supports, as changes are frequently made during construction at site which can affect detector coverage.
  - The installation should allow for easy detector removal for maintenance or repair.
1. The detector should be fixed to a stable supporting structure using the mounting bracket provided. The supporting structure must allow for horizontal adjustment of the detector orientation. The support structure should be in place prior to detector installation.
  2. The threaded flame path of the enclosure cover and body must be protected from damage during installation. Any such damage can destroy the validity of the enclosure.
  3. The detector electronics shall be protected from mechanical damage and external sources of EMI such as X-rays, RFI and electrostatic discharge.
  4. Fit the mounting bracket to the support structure using 8mm bolts (not provided). The detector (bracket) should be oriented to provide the desired coverage.
  5. The hex head bolts should be fitted to the enclosure body prior to mounting to the bracket. The detector enclosure

body should then be fitted to the mounting bracket. The bolts fit into key slots in the bracket. Twist the enclosure to locate the bolts; these are then tightened using a 6mm Allen key.

## Electrical Installation

In order to maintain compliance with the EMC regulations it is essential the electrical installation be engineered correctly.

- It is advisable to check the detection locations, prior to fabrication of the mounting supports, as changes are frequently made during construction at site.
  - Detector cabling must be segregated from cables carrying high-speed data or high energy and/or high frequency signals and other forms electrical interference.
  - The detector requires a clear unobstructed view of the local hazard. In order to avoid local obstructions, such as pipe-work and cable trays, a 2m helix should be allowed in the detector cabling.
  - The detector should only be installed just prior to commissioning. Experience shows that the detector can be damaged due to cable testing operations (Insulation Tests, etc)
1. Isolate all associated power supplies. Ensure that they remain OFF until required for commissioning.
  2. The threaded flame path of the enclosure cover and body must be protected from damage during installation. Any such damage can destroy the validity of the enclosure.
  3. The electronics subassembly shall be protected from mechanical damage and external sources of EMI such as X-rays, RFI and electrostatic discharge.
  4. The enclosure's external earth stud should be connected to a local earth point.
  5. Remove the blanking plug(s) from the enclosure body gland entries.
  6. Fit approved cable glands using sealing washers to maintain ingress protection.
  7. Prepare the cable tails. The cable screens should be cut back to the crotch at the detector and insulated from contact with the enclosure or any other local earth. The twist in each pairs should be maintained to within 1" (25mm) of the termination. Cable tails should be 8" (200mm) long.
  8. Where plastic junction boxes are used the cable screens (shields) should be maintained to within 1" (25mm) of the termination and fully insulated.
  9. Where unscreened cables are used for panel wiring, then all cables must be suitably twisted into pairs and video cables should be segregated from other signal sources.
  10. All cable screens (shields) should be connected to the local clean earth at the control panel. The screens and twisted pairs should be maintained to within 1" (25mm) of the terminations.

## Operation

### Detector Start-up procedure

When the power is initially turned on there is a delay of approximately thirty seconds. The system performs an internal test and system initialisation.

### Detector Signals

The Flame detector generates a 0-20mA signal to indicate its status, or provides relay outputs. This should be checked during the installation of the detector. Alternatively the status and operation of the device can be monitored by the colour of the LED illuminated.

!
WARNING

Operators must be properly trained and aware of what actions to take in the event of a fire being detected.

### Status Indicators

The detector LED indicator is used to reveal the Dräger Flame Detector 5000's current state, as shown below:

#### LED Status Diagnostic Chart

LED Colour	Status	Indicator
Steady OFF	No Power	○
Green	Healthy	●
Steady Yellow	Fault	●
Flashing Yellow/Green	24V/0V terminals polarity reversed.	●
Red	Alarm	●

#### Current (Source) isolated signal output

Event	Output
Catastrophic Failure	0mA
Optical Fault	2mA
Healthy condition	4mA
Alarm	18mA
Over range	21mA

The LED Status indicator is located on the face of the detector underneath the camera lens, as illustrated in the graphic below.

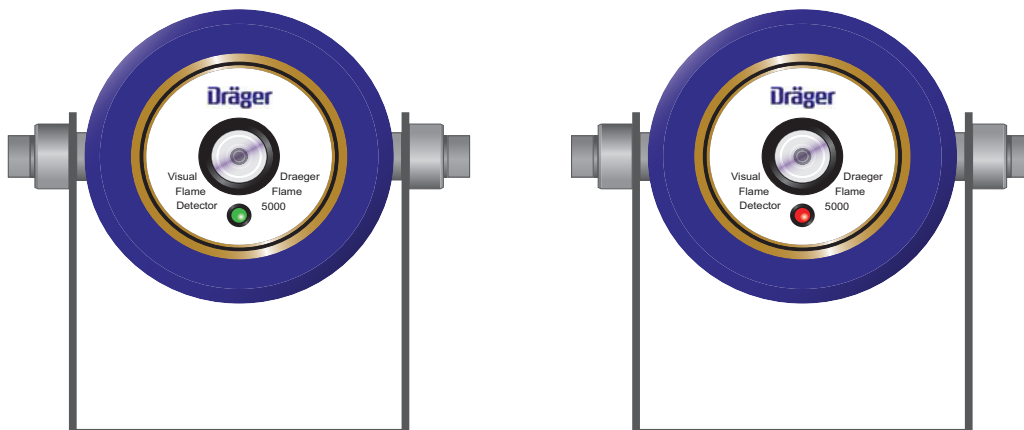

## Maintenance

### Detector Maintenance



Once installed there are no user serviceable parts within the detector. The only servicing requirements are to ensure that the detector is fully functional and to ensure that the lenses are clean.

The terminal compartment cover and front cover threads must be lightly lubricated with non-setting grease prior to re-assembly.

This maintenance schedule is intended for guidance only. The actual level of maintenance required will depend on the severity of the operating environment and the likelihood of damage or the rate of contamination from oil, sea spray, deluge system etc. It is advisable to regularly review maintenance reports and adapt the maintenance period to the operating environment. A function test of the detectors using the Dräger FS-5000 (See Accessories, page 26) should be carried out regularly.

### Maintenance Intervals

Periodic maintenance checks may be performed in accordance with appropriate codes of practice or local regulations e.g. in Europe EN 60079-17 applies.

These first five points relate to the general inspection and maintenance of the detector and faceplate, this should be carried out at least every 6 months.

- Detectors that require maintenance should be taken off line and inhibited. Detectors which require to be opened up will need to be isolated electrically. Ensure that panel wiring and terminations associated with all units under test are in good order.
- Ensure that detector mounting arrangements are secure and undamaged.
- Ensure that the detector enclosure is intact and undamaged.
- Ensure that all associated cables and glands are correctly made up, secure and undamaged.
- Clean the enclosure faceplate (outside) with a mild detergent solution and a soft cloth until the window is clear of all contamination. Wash the window thoroughly with clean water and dry with a clean lint free cloth or tissue. Assess requirement for opening the enclosure, for maintenance or cleaning.

The nine points below are for more specific inspection and maintenance of the detector enclosure, which should be performed at least once a year. These points focus as a close external visual inspection and internal inspection if required.

- Open the detector enclosure, if required, by removing the enclosure cover. This exposes the enclosure flame path and detector electronics. Avoid damage to the flame path and faceplate.
- Clean the enclosure cover and body flame paths with a dry clean cloth to remove any contamination. If the flame path or threads are badly pitted the component should be replaced.

- Check the 'O' ring seal on the enclosure cover to ensure that it is not damaged or perished; replace as required.  
NOTE: That the ingress protection is compromised if the seal is not correct.
- Clean the enclosure faceplate (inside) with a mild detergent solution and a soft cloth until the window is clear of all contamination. Wash the window thoroughly with clean water and dry with a clean lint free cloth or tissue.
- No-setting waterproof grease should be evenly applied to the flame path on both the enclosure cover and body.
- Clean the detector lens. This should be done with a soft, dry and clean cloth. Avoid touching the electronics.
- Clean the detector enclosure faceplate. Use a degreasing agent on the outside in order to remove deposits.
- Visually inspect detector electronics and inside the enclosure body for any sign of damage or moisture, replace or rectify as required.
- The enclosure cover must be screwed on to a minimum of 5 full turns or until fully tight and secured using the locking screw provided.

The remaining points cover detector function testing, this should be done on a continuous basis or every 6 months depending on the environment.

- Reinstate the detector back into service.
- Ensure that 'inhibits' are applied, then, using the Dräger FS-5000, function test the detector. Note the detector LED indicator, within the detector housing, changes colour to RED. Check the complete display system for correct function and indication.

### Functional Testing

The detector can be function tested using the Dräger FS-5000, which has been specifically designed to provide a convenient means of field testing the detector.

 <b>CAUTION</b>
<b>Use only Draeger approved parts and accessories with this equipment.</b>

 <b>CAUTION</b>
<b>Do not attempt to replace the window as the glass and the front cover are individually matched pairs to meet the stringent requirements of the hazardous area certification.</b>

 <b>CAUTION</b>
<b>To maintain safety standards, commissioning and regular maintenance should be performed by qualified personnel.</b>

## Fault Finding

### Removal of the Electronics

There are no user replaceable parts within the electronic module, any attempt to repair or dismantle the electronic sub-assemblies will void the warranty. If any fault is suspected within the electronics module the module is to be returned to Dräger Safety UK Ltd for investigation and repair if required.

### Diagnostics

It is impossible to provide fault diagnostics for every possible detector fault. In all cases it is advised that the following best practises are followed:

- Only make one change at a time (changing more than one part at a time makes diagnosis very difficult)
- Check the most obvious possible causes first
- Work systematically through the problem
- Keep good notes on the original problem, each step taken and the results observed

### Power Supply

If the detector LED indicator is OFF then there may be a power supply fault. When investigating power supply faults it is important to check that all voltages are within the detectors operating range (18V - 32V) under full load conditions as the voltages measured under no load conditions can be misleading.

### Live Video Images

The live video signal is susceptible to more potential problems than the alarm signals. The signal is an analogue transmission and available for operator scrutiny. The cabling is critical to video image quality. Due to the nature of the video signal, video corruption can appear differently on each detector/installation.

## Technical Specifications

### Mechanical

#### Enclosure

**Enclosure Material:** Aluminium Alloy Grade LM25, Stainless Steel 316

**Enclosure Finish:** Epoxy Coated Finish, Dräger Blue

**Weight:** 2.5 kg, 5.5 lbs (2.8 kg, 6.2 lbs Stainless Steel ver)

**Dimensions (L x D):** 220 x 100 mm, (9" x 4" inches)

**Cable Entries:** M20, M25 or 3/4" NPT

**Terminal Wire Size:** 2.5mm<sup>2</sup>

**Ingress Protection:** IP 66, NEMA 4X

#### Temperature & Humidity

**Operating T<sub>amb</sub>:** -60°C to +85°C T4

**Storage T<sub>amb</sub>:** -60°C to +85°C

**Humidity:** 5-95% Relative Humidity Non-condensing

#### Mounting

**Support Fixings:** M8 x2

**Vertical Adjustment:** 0-45°

**Axial (Horizontal) Adjustment:** ±45°



## Electrical

<b>Operating Voltage:</b>	18-32VDC (24VDC Nominal) inc ripple, (Max 30VDC in Canada)
<b>Supply Ripple:</b>	1V pk-pk
<b>Power Consumption:</b>	6W (max. 15W with Heater)
<b>Heater Power Consumption:</b>	12W
<b>Detector Shutdown Voltage:</b>	<17VDC
<b>(low supply)</b>	
<b>Power-On Delay:</b>	No more than 30 seconds, during in which System Testing and System Initialisation occurs.

### RS 485 Transceiver

<b>Line Termination Resistor:</b>	120 $\Omega$
<b>Driver Differential:</b>	1.5 VDC
<b>Driver Fan Out:</b>	0-3 UL
<b>Receiver Common Mode Input Range:</b>	-7 to +12 VDC
<b>Receiver Input Threshold:</b>	-0.2 VDC (LO) to +0.2 VDC (HI)
<b>Receiver Input Resistance:</b>	>12 k $\Omega$
<b>Receiver Unit Load:</b>	1

### Video Driver (Twisted Pair)

<b>Line Termination Resistor:</b>	150 $\Omega$
<b>Driver Output Resistance:</b>	150 $\Omega$
<b>Driver Differential Output Voltage:</b>	4 VDC
<b>Driver Differential Output Voltage (loaded):</b>	2 VDC
<b>Driver Shutdown Resistance (TRI-STATE):</b>	4.8 k $\Omega$
<b>Driver Fan Out:</b>	0-1 UL

## Approvals

### ATEX

Certificate Number: FM07ATEX 0033  
II 2 G Exd IIC

### IECEX

Certificate Number: FME 07.0002

### FM

Class I Div 1 Groups B, C, D, T4  
Ambient: -60°C to +85°C  
Class I Zone 1 AEx/Ex d IIC T4  
Ambient: -60°C to +85°C



### CE

GEC: EN55022 & 082

<b>Electromagnetic Compatibility:</b>	Emissions:	EN61000-6-3:2001
	Immunity:	EN50130-4:1995 +A1:1998 +A2:2003
	Conducted Emissions:	EN55022:1998 Class/Level B
	Radiated Emissions:	EN55022:1988 Class/Level B
	ESD:	EN61000-4-2:1995 ±6kV (Contact) ±8kV (Air)
	RF Field (Amplitude):	EN61000-4-3:2002 +A1:2002 10V/m 100% & 80% modulation
	Transient:	EN61000-4-4:1995 +A1:2001 +A2:2002 ±1kV
	Surge:	EN61000-4-6:1995 +A1:2001 Line - Line , Line - Earth ±1kV
	RF Field (Common Mode):	EN61000-4-6:1996 +A1:2001 10V rms 100% & 80% modulation
<b>Response Time:</b>		min. 4 seconds (upto 30 seconds max.)
<b>Operating Distance:</b>		2-44 m

### Hazardous Area Label

This label shows the certification and conditions of the Dräger Flame Detector 5000.

 <p>Dräger Safety U.K. Limited, Blyth, Northumberland, NE24 4RJ, U.K. Manufactured by: Micropack Engineering Aberdeen, Scotland, AB12 4RR</p>	<p>TYPE: <b>FLAME 5000</b></p> <p>SERIAL No: <input type="text"/></p> <p>YEAR: <input type="text"/></p> <p>ENTRY:</p> <p>M25 <input type="checkbox"/> ½" NPT <input type="checkbox"/> Single <input type="checkbox"/></p> <p>M20 <input type="checkbox"/> ¼" NPT <input type="checkbox"/> Dual <input type="checkbox"/></p>	 <p><b>APPROVED</b></p> <p>AMBIENT: -60°C +85°C</p>	<p>CE 1725 Ex II 2 G Ex d IIC T4</p> <p>AMBIENT: -60°C +85°C</p> <p>FM07ATEX 0033</p> <p>IECEX FME 07.0002</p> <p>Maximum Voltage: 30VDC</p> <p>Maximum Current: 700mA</p>	<p>TYPE 4, IP66</p> <p>Class I DIV 1 GROUPS B,C,D,T4</p> <p>AMBIENT: -60°C +85°C</p> <p>Class I Zone 1 AEx/Ex d IIC T4</p> <p>AMBIENT: -60°C +85°C</p> <p>SEAL CONDUIT WITHIN 18" OF ENCLOSURE ENTRANCE</p>	 <p><b>APPROVED</b></p>
<p><b>WARNING: DO NOT OPEN WHEN EXPLOSIVE ATMOSPHERE MAY BE PRESENT</b></p>		<p><b>WARNING: REFER TO FLAME 5000 TECHNICAL MANUAL BEFORE INSTALLING OR MAINTAINING THIS UNIT</b></p>			

## Accessories

Description	Part Number
Dräger FS-5000	420 93 07
Dräger CCTV Balanced Line to BNC Video Converter	420 93 27
Dräger Flame 5000, M20, 4-20mA, PAL video mode, Aluminium	420 93 08
Dräger Flame 5000, M20, Relay, NTSC video mode, Aluminium	420 93 09
Dräger Flame 5000, 3/4 NPT, Relay, NTSC video mode, Aluminium	420 93 10
Dräger Flame 5000, 3/4 NPT, 4-20mA, PAL video mode, Aluminium	420 93 11
Dräger Flame 5000, M25, 4-20mA, PAL video mode, Aluminium	420 93 33
Dräger Flame 5000, M25, Relay, NTSC video mode, Aluminium	420 93 34
Dräger Flame 5000, M20, 4-20mA, PAL video mode, Stainless Steel	420 93 20
Dräger Flame 5000, M20, Relay, NTSC video mode, Stainless Steel	420 93 21
Dräger Flame 5000, 3/4 NPT, Relay, NTSC video mode, Stainless Steel	420 93 22
Dräger Flame 5000, 3/4 NPT, 4-20mA, PAL video mode, Stainless Steel	420 93 23
Dräger Flame 5000, M25, 4-20mA, PAL video mode, Stainless Steel	420 93 35
Dräger Flame 5000, M25, Relay, NTSC video mode, Stainless Steel	420 93 36
Dräger Flame 5000, M20, 4-20mA, NTSC video mode, Aluminium	420 93 48
Dräger Flame 5000, M20, Relay, PAL video mode, Aluminium	420 93 49
Dräger Flame 5000, ¼ NPT, 4-20mA, NTSC video mode, Aluminium	420 93 50
Dräger Flame 5000, ¼ NPT, Relay, PAL video mode, Aluminium	420 93 51
Dräger Flame 5000, M25, 4-20mA, NTSC video mode, Aluminium	420 93 52
Dräger Flame 5000, M25, Relay, PAL video mode, Aluminium	420 93 53
Dräger Flame 5000, M20, 4-20mA, NTSC video mode, Stainless Steel	420 93 54
Dräger Flame 5000, M20, Relay, PAL video mode, Stainless Steel	420 93 55
Dräger Flame 5000, ¼ NPT, 4-20mA, NTSC video mode, Stainless Steel	420 93 56
Dräger Flame 5000, ¼ NPT, Relay, PAL video mode, Stainless Steel	420 93 57
Dräger Flame 5000, M25, 4-20mA, NTSC video mode, Stainless Steel	420 93 58
Dräger Flame 5000, M25, Relay, PAL video mode, Stainless Steel	420 93 59

# Supplier's Declaration of Conformity

## EC Declaration of Conformity

In accordance with ISO 17050-1:2000

We  
Of  
Micropack (Engineering) Ltd  
Fire Training Centre  
Schoolhill  
Portlethen  
Aberdeen , AB12 4RR

Herby declare that:

Equipment: **Colour Visual Flame Detector**  
Model Number: **Flame 5000**

Is in conformity with the applicable requirements of the following documents:

Parameter	Authority / Standard	Approval	Certificate
Hazardous area Certification	ATEX	Ex II 2 G D EExd,11C T4 IP66	FM07ATEX0033
Hazardous area Certification	NEC 505	Class1 Zone 1 AExd 11C T4	3029978
Hazardous area Certification	NEC 500	Class 1 Div 1 Groups B,C and D	3029978
Hazardous area Certification	IEC	Ex II 2 G D EExd,11C T4 IP66	FME07.0002
Fire Service Listing	FM	Class 3280,3600,3615,3810	3009845
CE Marked (Emissions)	EN61000-6-3:201	UKS	
CE Marked (Immunity)	EN50130-4+A1:1998+A2:2003	UKS	

I hereby declare that the equipment named above has been designed to comply with the relevant sections of the above referenced specifications. The unit complies with all applicable Essential Requirements of the Directives.

Signed: Patricia McQuire  
Full Name: PATRICIA Mc QUIRE  
Position: HSCQA MANAGER  
Date signed: 6/5/2008  
Location: ABERDEEN



## FIRE PROTECTION EQUIPMENT

This certificate is issued for the following equipment:

Flame 5000 – Color CCTV Flame Detector

Approval Guide Listing: Category: Electrical Signaling, Fire Detection, Flame-Actuated

The Flame 5000 is Approved for use at factory default settings. The color imaging detector incorporates an integral CCTV camera. The Flame 5000 operates from 18 to 30Vdc with firmware version 1.02. The detector dry contact Form C relay outputs connect to a compatible Approved control panel for alarm and trouble reporting. Fuels tested for response are Heptane and JP4 Jet Fuel. Operating temperature range is -60°C (-76°F) to +185°F. Suitable as explosionproof for use in Class I, Division 1, Groups B, C and D; flameproof for use in Class I, Zone 1, AEx d IIC with a T4 temperature class rating in hazardous (classified) locations, indoors and outdoors Type 4X / IP66.

Approved for:

Draeger Safety UK Ltd  
 Ullswater Close, Blyth Riverside Business Park, Blyth,  
 Northumberland, England NE24 4RG

This certifies that the equipment described has been found to comply with the applicable requirements of the following FM Approval Standards and other documents:

Approval Standards	Date	Other Standards	Organization, Designation	Date
3260	2000	CAN/ULC - S529		2002
3600	1998	CSA C22.2 No. 0.4-04		2004
3615	2006	CSA C22.2 No. 0.5		1982 (1999)
3610	2005	CSA C22.2 No. 30		1986 (R2003)
ANSI/NFPA 72	2002	CSA-C22.2 No. 94-M91		1991 (R2001)
		CSA-C22.2 No. 142-M1987		1987 (R2004)
		CAN/CSA E60079-0		2002 (R2006)
		CAN/CSA E60079-1		2002 (R2006)
		ANSI/IEC 60529		2004 2005
		CSA-C22.2 No. 60529		

Original Approval Project Identification: 3032967

Related Reports:

FM Approvals

*Patrick J. Byrne*  
 Patrick J. Byrne  
 Technical Team Manager, Electrical Systems

Approval Granted:

*2-July-2008*  
 Date

Cert. No. 3032967



Member of the FM Global Group

# 1 EC-TYPE EXAMINATION CERTIFICATE



2 **Equipment or Protective systems intended for use in Potentially Explosive Atmospheres - Directive 94/9/EC**

3 EC-Type Examination Certificate No: **FM07ATEX0033**  
4 Equipment or protective system:  
(Type Reference and Name) **FDS301 Visual Flame Detector**  
5 Name of Applicant: **Micropack Engineering Ltd.**  
6 Address of Applicant: **Fire Training Centre  
Schoolhill  
Portlethen  
Aberdeen  
Scotland AB12 4RR**

7 This equipment or protective system and any acceptable variation thereto is specified in the schedule to this certificate and documents therein referred to.

8 FM Approvals Ltd, notified body number 1725 in accordance with Article 9 of Directive 94/9/EC of 23 March 1994, certifies that this equipment has been found to comply with the Essential Health and Safety Requirements relating to the design and construction of equipment intended for use in potentially explosive atmospheres given in Annex II to the Directive.  
The examination and test results are recorded in confidential report number 3029978EC dated 20<sup>th</sup> November 2007

9 Compliance with the Essential Health and Safety Requirements, with the exception of those identified in item 15 of the schedule to this certificate, has been assessed by compliance with the following documents:  
EN 60079-0:2006, EN 60079-1:2004, and EN 60529:1991 + A1: 2000.

10 If the sign 'X' is placed after the certificate number, it indicates that the equipment is subject to special conditions for safe use specified in the schedule to this certificate.

11 This EC-Type Examination certificate relates only to the design, examination and tests of the specified equipment or protective system in accordance to the directive 94/9/EC. Further requirements of the Directive apply to the manufacturing process and supply of this equipment or protective system. These are not covered by this certificate.

12 The marking of the equipment or protective system shall include:



II 2 G Ex d IIC T4 Ta = -60°C to +85°C IP66

**Nicholas Ludlam**  
Deputy Certification Manager, FM Approvals Ltd.

Issue date: 21<sup>st</sup> November 2007



**THIS CERTIFICATE MAY ONLY BE REPRODUCED IN ITS ENTIRETY AND WITHOUT CHANGE**

FM Approvals Ltd. 1 Windsor Dials, Windsor, Berkshire, UK, SL4 1RS  
T: +44 (0) 1753 750 000 F: +44 (0) 1753 868 700 E-mail: [atex@fmapprovals.com](mailto:atex@fmapprovals.com) [www.fmglobal.com](http://www.fmglobal.com)

# SCHEDULE



to EC-Type Examination Certificate No. FM07ATEX0033

**13 Description of Equipment or Protective System:**

The **FDS-301 Visual Flame Detector** is a colour imaging based flame detector and incorporates an integrated CCTV system; Digital Signal Processing and Software Algorithms to process a live video image and interpret flame characteristics.

The equipment is an aluminium assembly consisting of a threaded enclosure body, a threaded back cover and a threaded window cover. An O-ring seal is provided at each end between the enclosure body and the back cover / window cover respectively in order to prevent the ingress of dust and water.

The internal equipment comprises an electronics plug in module and cable terminal assembly

The electrical ratings are 30 Vdc maximum and 700 mA maximum

**14 Special Conditions for Safe Use:**

None

**15 Essential Health and Safety Requirements:**

The relevant EHSRs that have not been addressed by the standards listed in this certificate have been identified and assessed in the confidential report identified in item 8.

**16 Test and Assessment Procedure and Conditions:**

This EC-Type Examination Certificate is the result of testing of a sample of the product submitted, in accordance with the provisions of the relevant specific standard(s), and assessment of supporting documentation. It does not imply an assessment of the whole production.

Whilst this certificate may be used in support of a manufacturer's claim for CE Marking, FM Approvals Ltd accepts no responsibility for the compliance of the equipment against all applicable Directives in all applications.

This Certificate has been issued in accordance with FM Approvals Ltd's ATEX Certification Scheme.

**17 Approved Drawings**

Drawing Number	Rev	Description
2200.5100	4.0	FDS301 Visual Flame Detector Technical Manual
2301.6004	0.2	FDS301 Enclosure Assembly
2301.6006	2.2	FDS301 Label
2301.6007	0.4	FDS301 Enclosure Body
2301.6008	0.3	FDS301 Window Cover
2301.6009	0.3	FDS301 Back Cover
2301.6010	0.3	FDS301 Window
2301.6011	0.2	FDS301 Window Locking Ring
3301.3009.03	1.1	FDS301 Enclosure & Electronics General Assembly

**THIS CERTIFICATE MAY ONLY BE REPRODUCED IN ITS ENTIRETY AND WITHOUT CHANGE**

Supplement 1 to  
EC-Type Examination Certificate No. FM07ATEX0033  
in accordance with Clause 6 of Annex III to Directive 94/9/EC.

Equipment or protective system:  
(Type Reference and Name) **FDS301 Visual Flame Detector**

Name of Applicant: **Micropack Engineering Ltd.**

Address of Applicant: **Fire Training Centre  
Schoolhill  
Portlethen  
Aberdeen  
Scotland AB12 4RR**

The examination results are recorded in confidential report number Supplement 1 to Report No 3029978EC dated 10 July 2008

Description of the supplements and modifications:

12 Minor modifications to the enclosure and internal circuits not affecting explosion safety:



II 2 G Ex d IIC T4 Ta = -60°C to +85°C IP66

17 **Approved Drawings**

Drawings affected	Rev	Title / Description
2200.5100	7.0	FDS301 Visual Flame Detector Technical Manual
2301.6004	2.3	FDS301 Enclosure Assembly
2301.6006	2.4	FDS301 Label
2301.6007	4.2	FDS301 Enclosure Body
2301.6008	4.2	FDS301 Window Cover
2301.6009	3.2	FDS301 Back Cover
2301.6010	3.2	FDS301 Window
2301.6011	2.1	FDS301 Window Locking Ring
2301.6019	2.2	FDS301 Window Glass Assembly Procedure
3301.3001.01	1.2	FDS301 Cable Termination Assembly
3301.3001.03	1.2	FDS301 Cable Termination Assembly
3301.3001.04	1.2	FDS301 Cable Termination Assembly
3301.3007.01	2.0	FDS301 Power Input & Relay Assembly
3301.3007.03	2.0	FDS301 Power Input & Relay Assembly
3301.3007.04	2.0	FDS301 Power Input & Relay Assembly
3301.3008.03	1.3	FDS301 Electronics General Assembly
3301.3009.03	1.2	FDS301 Enclosure & Electronics General Assembly

**Andrew Was**  
General Manager, FM Approvals Ltd.

Issue date: *10<sup>th</sup> July 2008.*



**THIS CERTIFICATE MAY ONLY BE REPRODUCED IN ITS ENTIRETY AND WITHOUT CHANGE**

FM Approvals Ltd. 1 Windsor Dials, Windsor, Berkshire, UK. SL4 1RS  
T: +44 (0) 1753 750 000 F: +44 (0) 1753 868 700 E-mail: [atex@fmapprovals.com](mailto:atex@fmapprovals.com) [www.fmglobal.com](http://www.fmglobal.com)



Supplement 3 to  
EC-Type Examination Certificate No. FM07ATEX0033  
in accordance with Clause 6 of Annex III to Directive 94/9/EC.

Equipment or protective system:  
(Type Reference and Name) FDS301 Visual Flame Detector

Name of Applicant: Micropack Engineering Ltd.

Address of Applicant: Fire Training Centre  
Schoolhill  
Portlethen  
Aberdeen  
Scotland AB12 4RR

The examination results are recorded in confidential report number Supplement 3 to Report No 3029978EC dated 14 July 2008

Description of the supplements and modifications:

12 Alternative material of construction in stainless steel with minor changes to the internal bore



II 2 G Ex d IIC T4 Ta = -60°C to +85°C IP66

17 Approved Drawings

Drawings	Rev	Title / Description
2301.6013	2.1	Enclosure painting details
2301.6004	2.4	FDS301 Enclosure Assembly
2301.6007	4.3	FDS301 Enclosure Body
2301.6008	4.3	FDS301 Window Cover
2301.6009	3.3	FDS301 Back Cover
2200.5100	8.0	FDS301 Visual Flame Detector Technical Manual
FD5000	2	Manual – Flame 5000

Andrew Was  
General Manager, FM Approvals Ltd.

Issue date: 14<sup>th</sup> July 2008.



**THIS CERTIFICATE MAY ONLY BE REPRODUCED IN ITS ENTIRETY AND WITHOUT CHANGE**

FM Approvals Ltd, 1 Windsor Dials, Windsor, Berkshire, UK, SL4 1RS  
T: +44 (0) 1753 750 000 F: +44 (0) 1753 868 700 E-mail: [atex@fmapprovals.com](mailto:atex@fmapprovals.com) [www.fmglobal.com](http://www.fmglobal.com)

FM F ATEX 025 (Feb/07)

Page 1 of 1

Supplement 2 to  
EC-Type Examination Certificate No. FM07ATEX0033  
in accordance with Clause 6 of Annex III to Directive 94/9/EC.

Equipment or protective system:  
(Type Reference and Name)                      **FDS301 Visual Flame Detector**

Name of Applicant:                                      **Micropack Engineering Ltd.**

Address of Applicant:                                      **Fire Training Centre  
Schoolhill  
Portlethen  
Aberdeen  
Scotland AB12 4RR**

The examination results are recorded in confidential report number Supplement 2 to Report No 3029978EC dated 11 July 2008

Description of the supplements and modifications:

- 12    **New label and Manual covering the unit being supplied by Draeger as a Flame 5000 Colour CCTV Flame Detector**



**II 2 G Ex d IIC T4 Ta = -60°C to +85°C IP66**

- 17    **Approved Drawings**

Drawings	Rev	Title / Description
3301.3012	1.1	Label – Flame 5000
FD5000	1	Manual – Flame 5000

**Andrew Was**  
General Manager, FM Approvals Ltd.

Issue date: *11<sup>th</sup> July 2008*



**THIS CERTIFICATE MAY ONLY BE REPRODUCED IN ITS ENTIRETY AND WITHOUT CHANGE**

FM Approvals Ltd. 1 Windsor Dials, Windsor, Berkshire, UK. SL4 1RS  
T: +44 (0) 1753 750 000 F: +44 (0) 1753 868 700 E-mail: [atex@fmapprovals.com](mailto:atex@fmapprovals.com) [www.fmglobal.com](http://www.fmglobal.com)

FM F ATEX 025 (Feb/07)

Page 1 of 1

**Draeger Safety UK Ltd**

Ullswater Close  
Blyth Riverside Business Park  
Blyth, Northumberland  
NE24 4RG, United Kingdom  
Tel: +44 (0)1670 352 891  
Fax: +44 (0)1670 540 033  
[www.draeger.com](http://www.draeger.com)

**Distributed in the US by:**

**Draeger Safety, Inc**

101 Technology Drive  
Pittsburgh, PA 15275  
USA  
Tel: +1 412 787 83 83  
Fax: +1 412 787 22 07  
Telex: 0230866704